

Polymer Lithium-ion Battery

Product Specification

Model: 6745135-10C

All 7 Sheets

1、 Scope

This product specification describes this polymer lithium-ion battery. Please use the test methods that recommend in this specification. If you have any opinions or advices about the test items and methods, please contact us. Please read the cautions recommended in the specifications first, take the credibility measure of the cell's using.

If the cells should be using at the environment that not preferred in this document, please connect us first and get our authorization. For the reason of stable performance and better safety, battery pack with more than 2 cells connected in serial way should be charged with a balance charger.

It is claimed that we should have no any responsibility with the contingency and loss due to the cells' wrong usage (not preferred in the product specification).

2、 Product Type, Model and Dimension

2.1 Type: Polymer lithium-ion battery

2.2 Model: [6745135-10C](#) (Cell adding Ni Tabs)

2.3 Cell Dimension (Max, Thickness×Width×Length, mm): [7.0 x 46.0 x 138.0](#)

3、 Specification

Item	Specifications	Remark
Nominal Capacity	4000mAh±5%	0.2C ₅ A discharge, 25℃
Nominal Voltage	3.70V	Average Voltage at 0.2C ₅ A discharge
Standard Charge Current	0.2 C ₅ A	Working temperature: 0~45℃
Max Charge Current	1C ₅ A	Working temperature: 0~45℃
Charge cut-off Voltage	4.2V±0.05V	CC/CV
Discharge Current	Continuously:10C₅A; Max: 15C₅A	Working temperature: 0~60℃
Discharge cut-off Voltage	2.75V	
Cell Voltage	3.76-3.90V	When leave factory
Impedance	≤10mΩ	AC 1KHz after 50% charge,25℃
Weight	Approx:91g	
Storage temperature	≤1month	-10~45℃
	≤3month	0~30℃
	≤6month	0~30℃
Storage humidity	65±20% RH	Best 20±5℃ for long-time storage

4、 General Performance

Definition of Standard charging method: At 20±5℃, charging the cell initially with constant current 0.2C₅A till voltage 4.2V, then with constant voltage 4.2V till current declines to 0.05C₅A.

Item	Test Methods	Performance	
4.1	0.2C Capacity	After standard charging, laying the battery 0.5h, then discharging at 0.2C ₅ A to voltage 2.75V, recording the discharging time.	≥300min
4.2	10C Capacity	After standard charging, laying the battery 0.5h, then discharging at 1C ₅ A to voltage 2.75V, recording the discharging time.	≥4.5min
4.3	Cycle Life	Constant current 1C ₅ A charge to 4.2V, then constant voltage charge to current declines to 0.05C ₅ A, stay 5min, constant current 1C ₅ A discharge to 2.75V, stay 5min. Repeat above steps till continuously discharging time less than 36min.	≥300times

4.4	Capability of keeping electricity	20±5℃, After standard charging, laying the battery 28days, discharging at 0.2C ₅ A to voltage 2.75V, recording the discharging time.	≥240min
-----	-----------------------------------	---	---------

5. Environment Performance

Item		Test Methods	Performance
5.1	High temperature	After standard charging, laying the battery 4h at 60℃, then discharging at 0.2C ₅ A to voltage 2.75V, recording the discharging time.	≥240min
5.2	Low temperature	After standard charging, laying the battery 4h at -20℃, then discharging at 0.2C ₅ A to voltage 2.75V, recording the discharging time.	≥210min
5.3	Constant humidity and temperature	After standard charging, laying the battery 48h at 40±2℃, RH 93±2%. Recording 0.2C ₅ A discharging time	No distortion No electrolytes leakage ≥270 min

6. Mechanical Performance

Item		Test Methods	Performance
6.1	Vibration	After standard charging, put battery on the vibration table. 30 min experiment from X,Y,Z axis. Scan rate: 1 oct/min; Frequency 10-30Hz, Swing 0.38mm; Frequency 30-55Hz, Swing 0.19mm.	No influence to batteries' electrical performance and appearance.
6.2	Collision	After vibration test, batteries were laying on the vibration table about X, Y, Z axis. Max frequency acceleration: 100m/s ² ; collision times per minutes: 40~80; frequency keeping time 16ms; all collision times 1000±10.	No influence to batteries' electrical performance and appearance.
6.3	Drop	Random drop the battery from 1.0m height onto wood board one times.	No explosion or fire

7. Safety Test

Test conditions: The following tests must be measured at flowing air and safety protection conditions. All batteries must standard charge and lay 24h.

Item		Test Methods	Performance
7.1	Over charge	At 20±5℃, charging batteries with constant current 3C ₅ A to voltage 5V, then with constant voltage 5V till current decline to 0. Stop test till batteries' temperature 10℃ lower than max temperature.	No explosion or fire
7.2	Over discharge	At 20±5℃, discharge battery with 0.2C ₅ A continuously 12.5h.	No explosion or fire
7.3	Short-circuit	At 20±5℃, connect batteries' anode and cathode by wire which impedance less than 50mΩ, keep 6h.	No explosion or fire
7.4	Extrusion	At 20±5℃, put the battery in two parallel steel broad, add pressure 13kN.	No explosion or fire
7.5	Thermal shock	Put the battery in the oven. The temperature of the oven is to be raised at 5±1℃ per minute to a temperature of 130±2℃ and remains 60 minutes.	No explosion or fire

8. Cautions

8.1 Cautions of batteries' operation

The batteries must be careful of proceed the operation for its soft package.

8.1.1 Aluminum packing materials

The aluminum packing material was easily damaged by the sharp edge part, such as nickel-tabs.

- (1) forbid to use the sharp part touching the battery;
- (2) should cleaning working condition, avoiding the sharp edge part existence;
- (3) forbid to pierce the battery with nail and other sharp items;
- (4) the battery was forbidden with metal, such as necklace, hairpin etc in transportation and storage.

8.1.2 Sealed edge

Sealing edge is very easily damaged and don't bend it.

The Al interlayer of package has good electric performance. It's forbidden to connect with exterior component for preventing short-circuits.

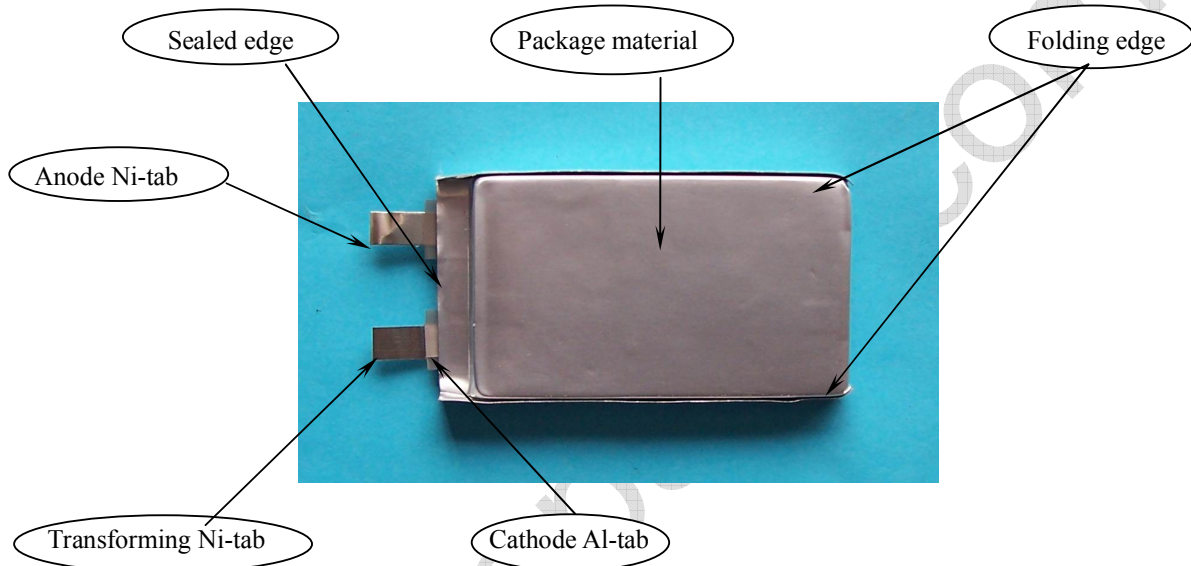

Fig.1. Exterior schematic of polymer lithium-ion cells

8.1.3 Folding edge

The folding edge is formed in batteries' processes and passed all hermetic tests, don't open or deform it. The Al interlayer of package has good electric performance. It's forbidden to connect with exterior component for preventing short-circuits.

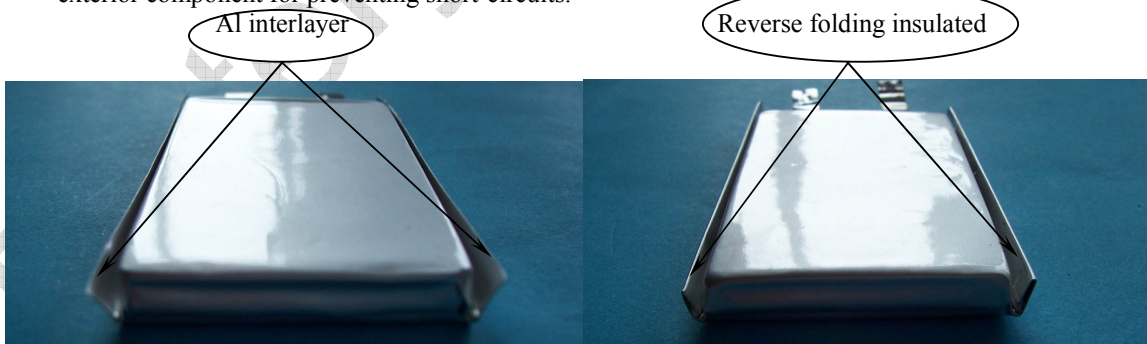

Fig.2. Single folding edge schematic of PL cells

Fig.3. Reverse folding edge schematic of PL cells

8.1.4 Tabs

- (1) The batteries' tabs are not so stubborn especially for aluminum tabs. Don't bend tabs.
- (2) The tab-tapes are used to isolate The anode /cathode tabs from Aluminum packing materials to prevent short-circuit, so prohibit manicuring of the tab-tapes.

8.1.5 Mechanical shock

- (1) Don't fall, hit, bent the batteries' body.
- (2) Don't knock on by sinker or trample the batteries.
- (3) Don't sling the batteries.

8.1.6 Short-circuit

Short-circuit is strictly prohibited. It should damage batteries badly.

- (1) Don't connect the anode and cathode of the batteries to avoid short-circuit.
- (2) Prohibit short-circuit of the anode (or cathode) and aluminum layer of Aluminum packing materials.

8.2 Standard Test Environment for polymer lithium-ion batteries

Environment temperature: $20 \pm 5^{\circ}\text{C}$ Humidity: 45-85%

8.3 Cautions of charge & discharge

8.3.1 Charge

Charging current should be lower than values that recommend below. Higher current and voltage charging may cause damage to cell electrical, mechanical, safety performance and could lead heat generation or leakage.

- (1) Batteries charger should charging with constant current and constant voltage mode;
- (2) Charging current should be lower than (or equal to) $1C_5A$;
- (3) Temperature $0 \sim 45^{\circ}\text{C}$ is preferred when charging;
- (4) Charging voltage must be lower than 4.25V.

8.3.2 Discharge

- (1) Discharging current must be lower than (or equal to) $2C_5A$;
- (2) Temperature $-20 \sim 60^{\circ}\text{C}$ is preferred when discharging;
- (3) Discharging voltage must not be lower than 2.75V.

8.3.3 Over-discharge

It should be noted that the cell would be at an over-discharge state by its self-discharge. In order to prevent over-discharge, the cell shall be charged periodically to keeping voltage between 3.7-3.9V. Over-discharge may cause loss of cell performance. It should be noted that the cell would not discharge till voltage lower than 2.75V.

8.4 Storage of polymer lithium-ion batteries

The environment of long-time storage:

Temperature: $20 \pm 5^{\circ}\text{C}$;

Humidity: 45-85%;

Batteries were 40~60% charged.

In case of over-discharge, batteries should be charged for one time every 3 months while storing. Batteries should be discharged and charged after being stored more than a year in order to activate it and restore energy. Please charge the battery with constant current $0.5C_5A$ for 1 hour so that it has some storage of charge for properly using.

Charge and discharge afresh to active and renew battery energy after storage above 1 year.

8.5. Transportation of polymer lithium-ion batteries

The batteries should transportation with 10~50% charged states.

8.6. Others

Please note cautions below to prevent cells' leakage, heat generation and explosion.

Prohibition of disassembly cells;

Prohibition of cells immersion into liquid such as water or seawater;

Prohibition of dumping cells into fire;

Prohibition of using damaged cells. The cells with a smell of electrolyte or leakage must be placed away from fire to avoid firing.

In case of electrolyte leakage contact with skin, eye, physicians shall flush the electrolyte immediately with fresh water and medical advice is to be sought.

9. Notice of Designing Battery Pack

9.1 Pack design

Battery pack should have sufficient strength and battery should be protected from mechanical shock. No sharp edge components should be inside the pack contains the battery.

9.2 PCM design

The overcharge threshold voltage should not be exceeding 4.25V.

The over-discharge threshold voltage should not be lower than 2.3V.

The PCM should have short protection function built inside.

9.3 Tab connection

Ultrasonic welding or spot welding is recommended to connect battery with PCM or other parts.

If apply manual solder method to connect tab with PCM, the notice below is very important to ensure battery performance.

- (1) The electric iron should be temperature controlled and ESD safe;
- (2) Soldering temperature should not exceed 350°C;
- (3) Soldering time should not be longer than 3s, keep battery tab cold down before next soldering;
- (4) Soldering times should not exceed 5 times;
- (5) Directly heat cell body is strictly prohibited, battery may be damaged by heat above approx. 100°C.

9.4 Cell fixing

The battery should be fixed to the battery pack by its large surface area. No cell movement in the battery pack should be allowed.

9.5 Cells replacement

The cell replacement should be done by professional people.

Prohibit short-circuit between cells' Al package and exterior component.

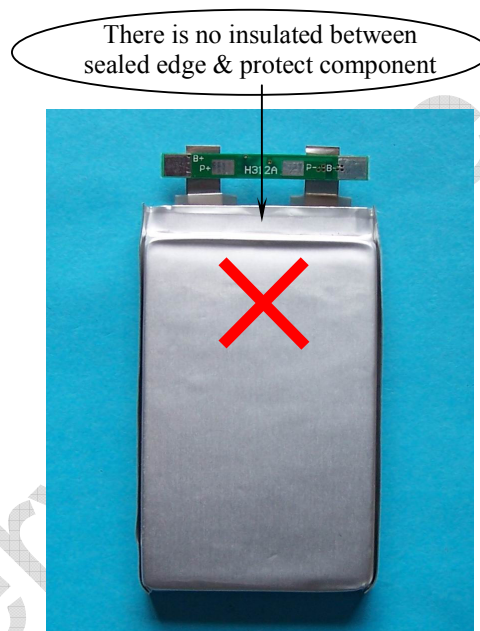
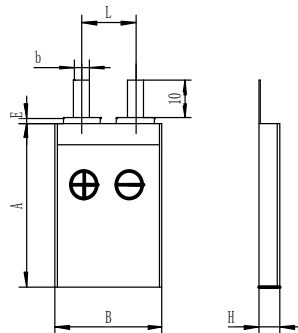
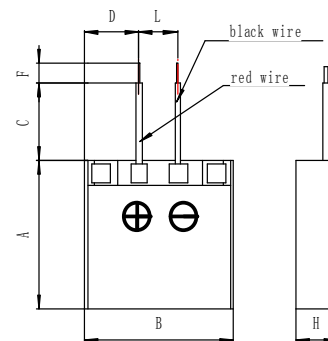

Fig.4. Schematic of wrong assembly

10. Schematic of Battery:



✓ Cell or adding Ni tabs



□ Cell adding wire

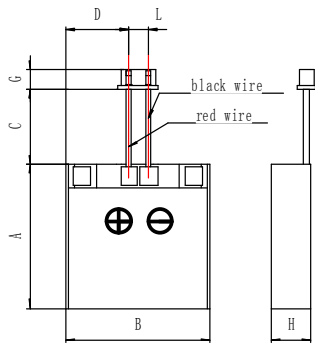

Cell adding PCM, wire

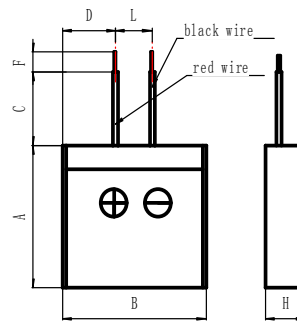

Cell adding wire

Parameter: ✓

Sign	Item	Max (mm)	Remark	Sign	Item	Max (mm)	Remark
A	Length	138.0		L	Space between Tabs	24±0.5	
B	Width	46.0		E	PP membrane Length	N/A	
H	Thickness	7.0		b	Tab Width	10	
	Wire Standard	/			Plug Standard	/	