

**Instruction Manual
Of
Solar / DC Charge Controller (30A Rate) for 12V/24V SLA / LFP Battery with
LCD Display**



AA Portable Power Corp (<http://www.batteryspace.com>)
Address: 860 S, 19th St, Unit A, Richmond, CA, 94804
Tel: 510-525-2328
Fax: 510-439-2808
Email: Sales@batteryspace.com
Prepared & Approved by Louis (01/10/08)

1 Characteristic

- PWM or ON/OFF series battery charging
- state of charge (SOC) battery regulation
- battery Ah setting, boost charging, equalizing charging, float charging
- automatic load reconnection, manual load switch
- automatic selection of voltage (12 V / 24 V) • temperature compensation
- lighting control and timer setting options during nighttime(for type –T)
- LCD display: SOC as a fuel gauge, all system parameters in digital value, system status as symbols
- full circuit protection, electronic fuse • field adjustable parameters by four buttons

2 Controller panel instructions

LCD digital and figure display

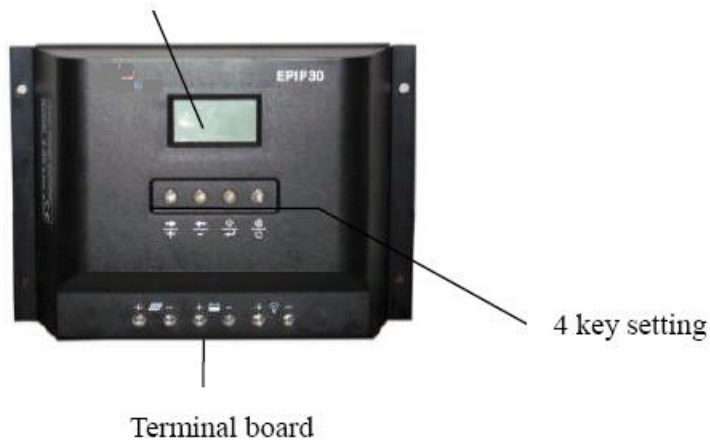

3 Installation:

Connect the individual components to the symbols provided, they are solar panel, battery and loads in order. Only install the regulator near the battery on a suitable surface. This surface should be solid, stable, even, dry and nonflammable. The battery cable should be as short as possible (1-2 m) and have a suitable cable diameter size to minimize loss, e.g. use 2.5 mm² at 10 A and 2 m length; 4 mm² at 20 A and 2m length; 6 mm² at 30 A and 2 m length.

Observe the following connection sequence during commissioning:

1. Connect the battery to the charge regulator - plus and minus, note the fuse current should be 2 or 2.5 times of the rated current.
 2. Connect the photovoltaic module to the charge regulator - plus and minus
 3. Connect the consumer to the charge regulator - plus and minus
- Please observe that the automatic adjustment to 12V / 24V systems does not function properly, if this sequence order is not followed. An improper sequence order can damage the battery!

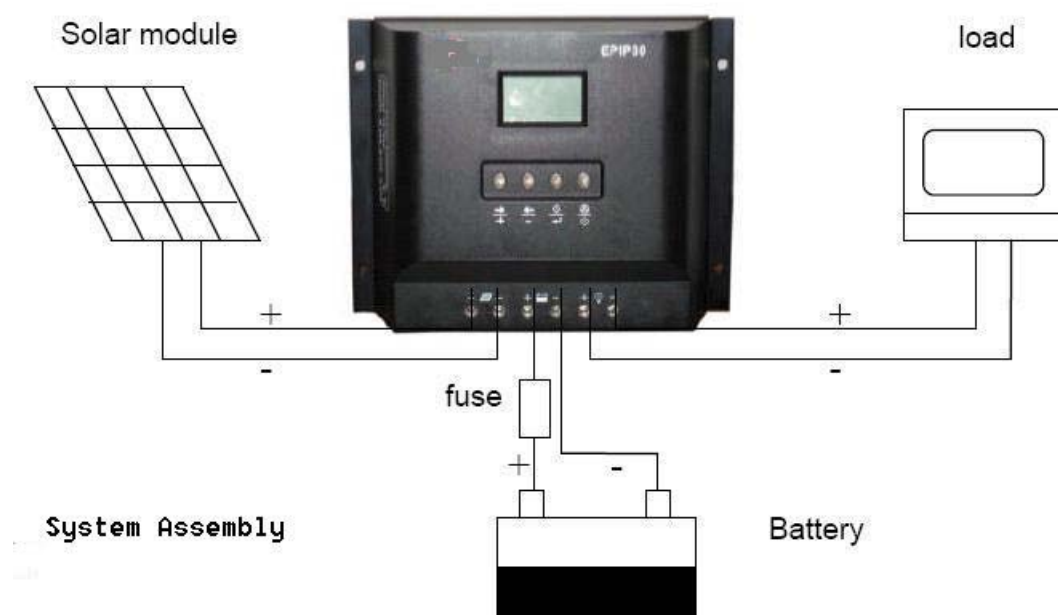

4 Operation & instructions:

- 4.1 Keys & instructions (from left to right)
- K1: reading status, switch to next figure; Setting status, switch to next function or increase the setting data.
 - K2: Reading status, switch to the previous figure; setting status, switch to the previous function or decrease the setting data.

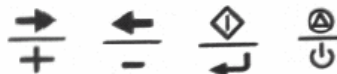

- K3: On reading status, press K3, then on setting status; on setting status, press K3, and save the data, back to reading status.
- K4: cancel/power switch, on setting status, no saving with K4. On reading status, K4 is power switch while loads are working. Recovery key while it's short-circuited or over load.

4.2 Display instructions: LCD display as the setting market:

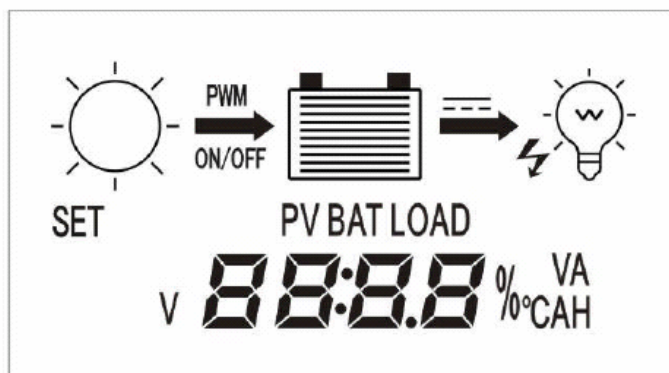

- 1) sun, daytime , night ; flashing shows the over load status.
- 2) Charging mode . PWM charging or ON/OFF switch; users can choose any method.
- 3) battery. The strips inside show the status of charging or discharging and present capacity.
 - If discharging, the strips will reduce.
 - If charging, the strips will increase.
 - Without charging or discharging, the strips inside will remain the status.
 - Every strips equals 10% of battery capacity.
 - represents the status of battery. flashes when over discharging. It stops flashing when goes back to normal charging.
- 4) DC output.
- 5) represents load, shows load and trouble status. is on when its working well. is on, shows the output is connected.
 - Load is flashing when over load, reduce the load, and press K4 to resume..
 - While short circuit protection, load and lighting flashes, then return to normal automatically after 10 minutes. If there are 2 short circuit protection in concession in 11 minutes, users need check loads and connects, then press K4.

- 6) LCD displays "PV", "BAT", "Load" for solar module, battery or load separately.
- 7) "SET" shows on setting status.
- 8) **88.88** at bottom of LCD display shows parameters.
- 9) Displays in lower right: "V"—voltage, "A" —ampere, "AH"—battery capacity, "°C"—temperature.

4.3 Operation instructions:

4.3.1 System is on reading status after its assembly. The LCD display: xx.xV;

4.3.2 Reading specifications: On reading status, press K1, K2 and will repeating the following specifications.

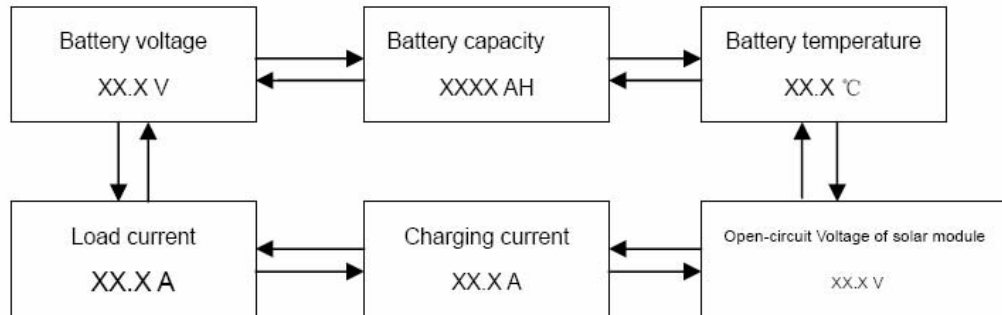

4.3.3 battery capacity modify: while display battery capacity XXXXAH, press k3 into setting mode, battery unit "AH" &"SET" is flashing, modify the data through K1/K2, press one time, battery capacity will be up/down 10Ah, the maximum is 5000, the minimum is 50; Press k3 for saving or K4 for back to the reading status.

4.3.4 charging mode modify: while on displaying Voltage of solar module, press K3 into setting mode, "SET" & "▶" is flashing, press K1/K2 to select PWM—▶ or ON/OFF_{ON/OFF} mode, K3 for saving modify or K4 for back to reading mode;

4.3.5 While in the discharging mode, the strip of battery  will be decreased dynamically. While in the charging mode, the strip of the battery will be increased accordingly. While there is on the balanced condition or no charging/discharging, the strip of the battery is the battery capacity, one strip is equal to 10% of the battery.

5 Security and protections

The controller has the protections against over voltage, over current, short circuit and TVS lightning proof

Note: lightning proof is the last protection of the controller. In those areas where lightning is quite often, use professional lightning proof system. Without the lightning proof system, guarantee will be void, if it's damaged by the lightning.

Make sure of proper cooling while installation.

6. Guarantee & customer service

one year warranty,

7 Specifications

Type		EPIP-40 /30	
Rated charging current		30A(max39A)	
Rated load current (Ie)		30A	
Over load, short circuit protection	1.25 times of Ie for 60secs, 1.5 times of Ie by for 5secs overload protection; ≥2 time of Ie short circuit protection		
Self consumption	Control mode: <10 mA; LED & LCD display (MAX) <10mA; Total (Max) < 20mA		
System voltage	12/24V AUTOWORK;		
Work temperature	industrial (I series): -20°C to +50°C		
Battery capacity	Battery in parallel from 50AH to 5000ah		
Boost charging	14.8V; ×2/24V;		
equalizing charging	14.4V; ×2/24V;		
Float charging	13.4V; ×2/24V;		
Temperature	5mv/°C/2v;		
Over discharge voltage	11.1V; ×2/24V;		
Control mode	PWM charging mode & ON/OFF mode for options, control point voltage is the intelligent compensation modify of the battery.		

Operation temperature: -35 to +55

Compliance: CE world Bank

Note: values are for 12V. Use 2X for 24V.

8. Optimized Battery Charging Curve

4 Stage of charging to increase battery capacity and life

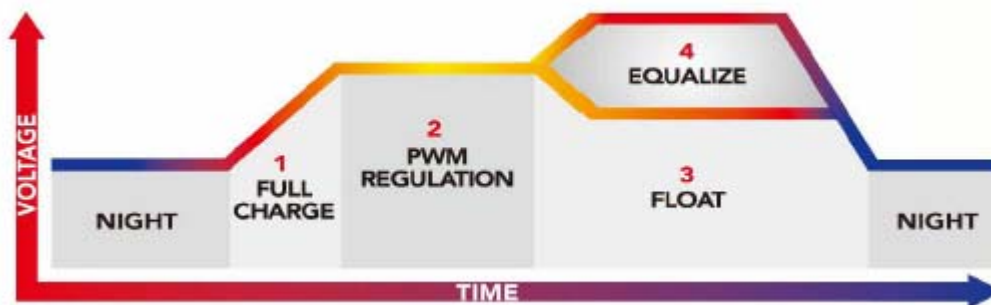

9. Mechanical Drawing

